

S H I C C „L .









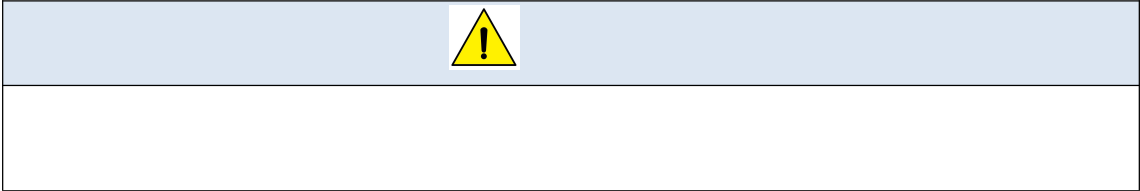

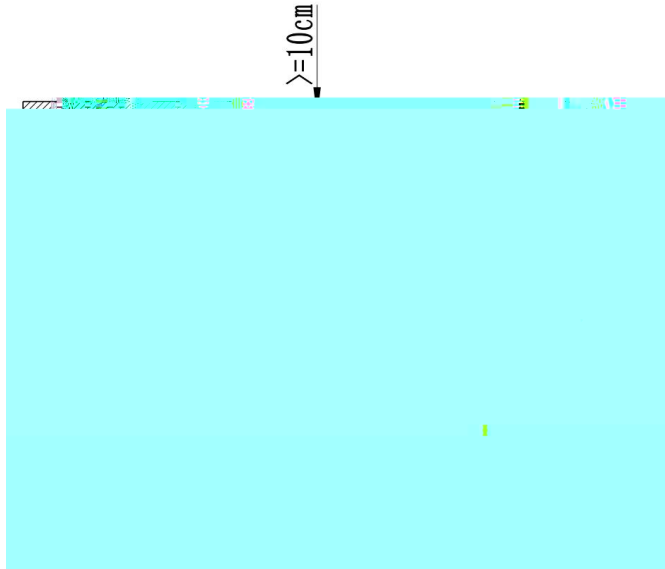

要求滤波器输入和输出线尽量远离布线，输入电源线在机箱内尽量短

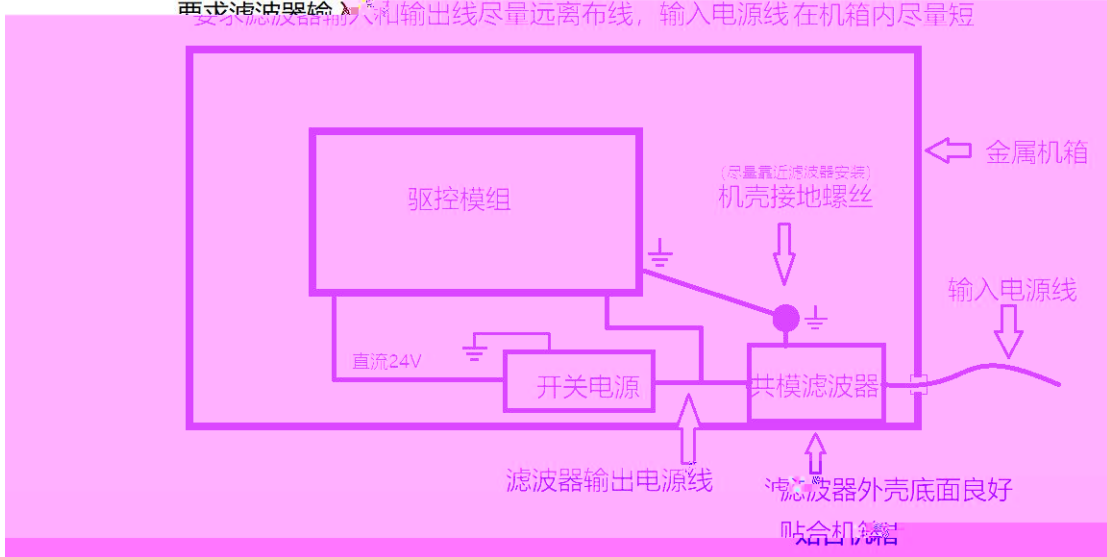

*

*

高压线路和低压线路远离布线，马达输出连接线远离信号IO(输入输出)和通讯电缆

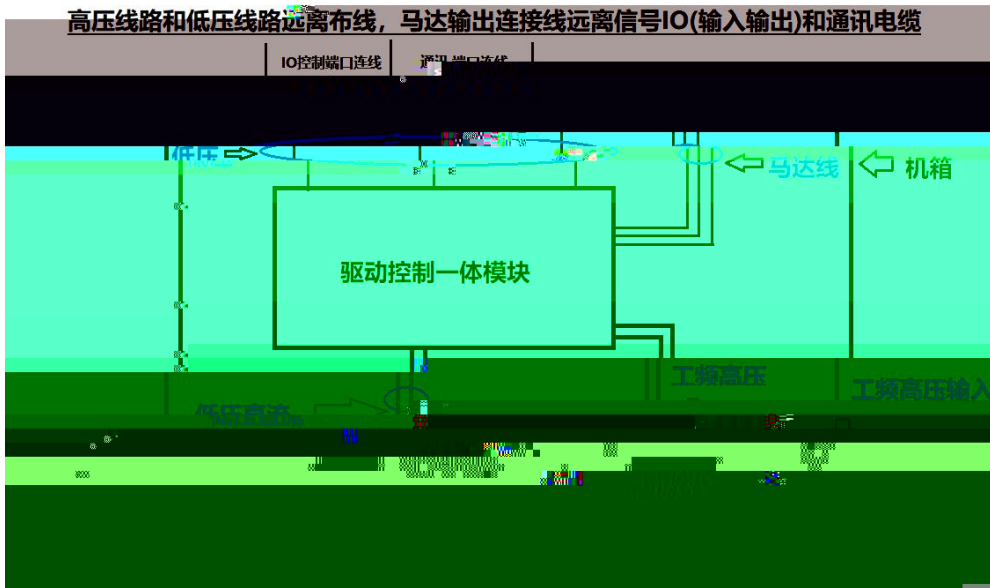

*

*

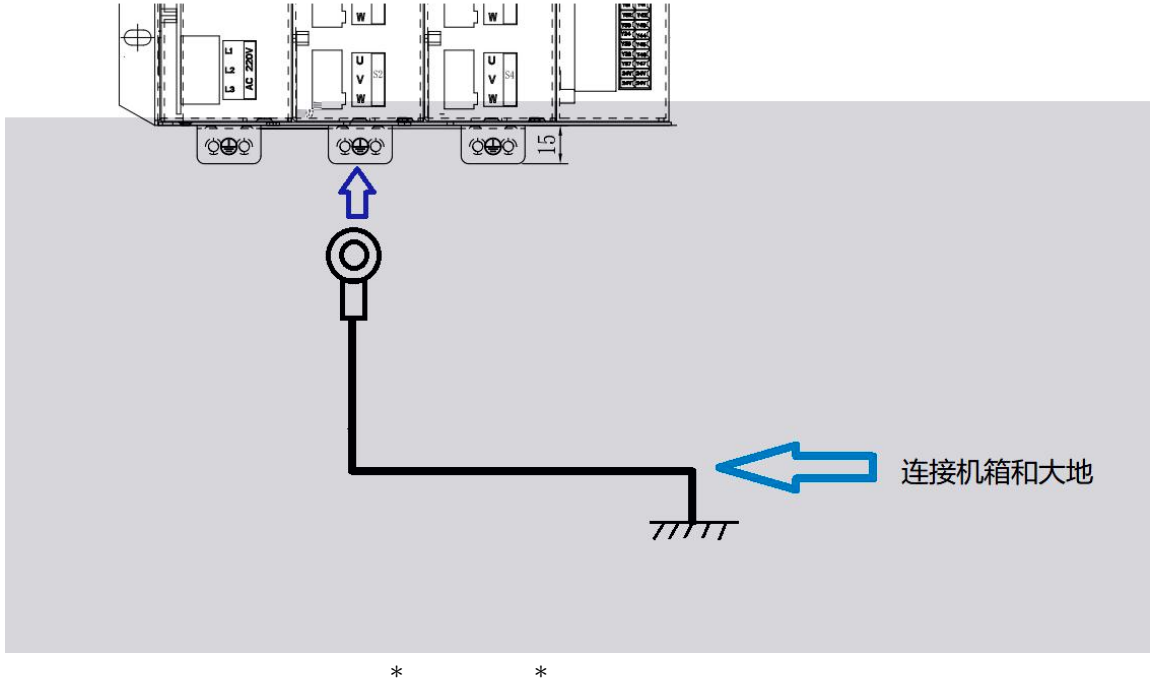

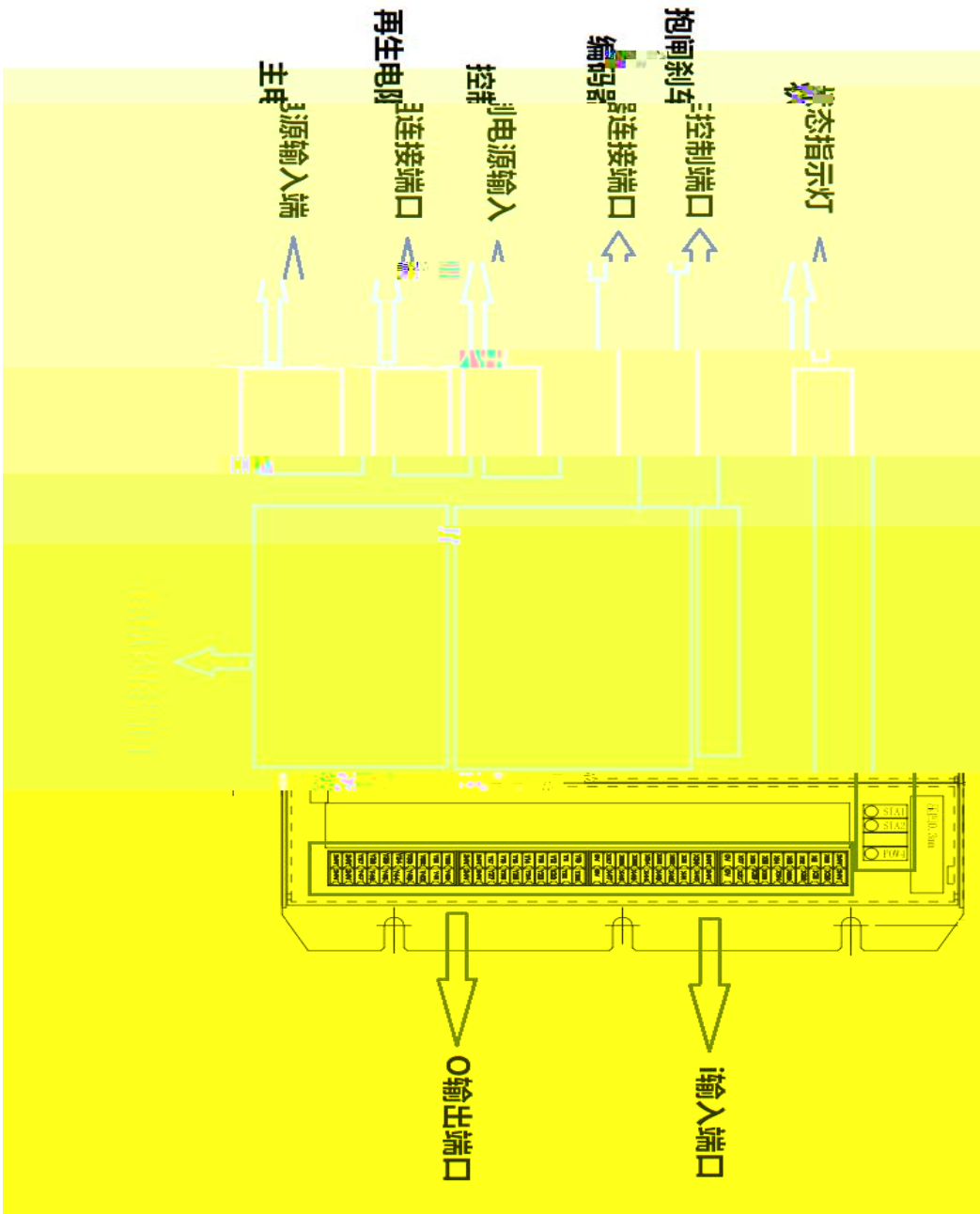

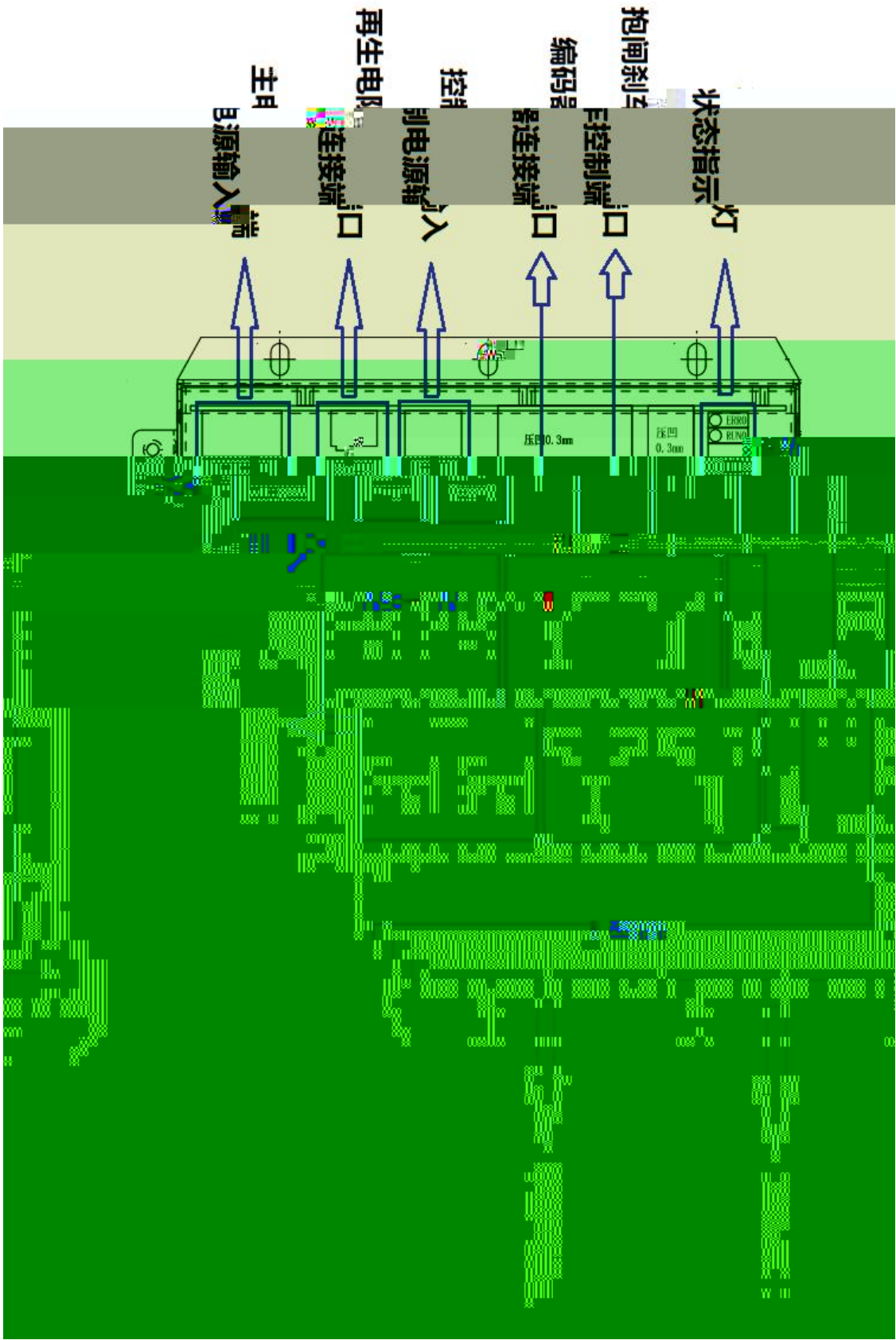



EC-L3	EC-L4		

	S1	S3	
	S2	S4	

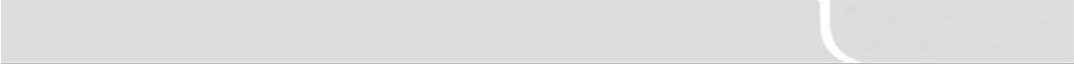

主站单元输入输出接线图例

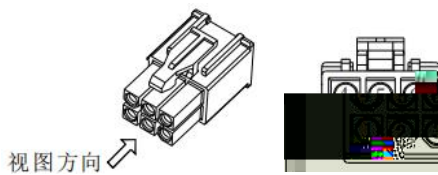
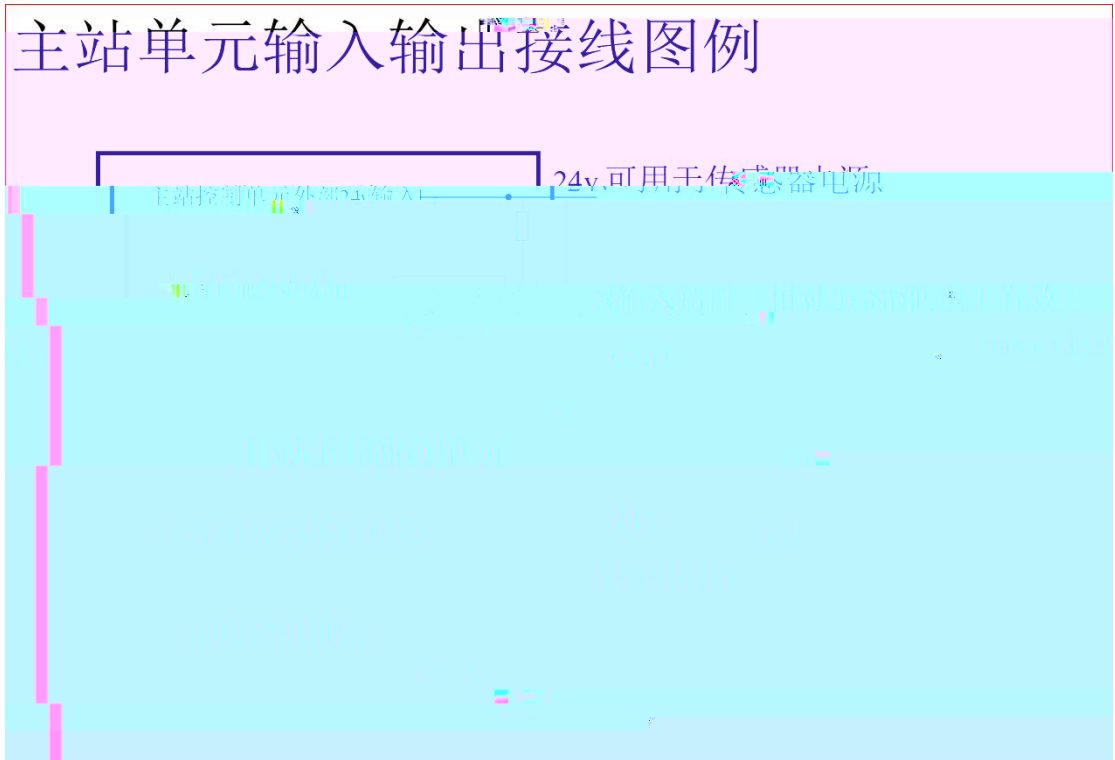

1 750W

-

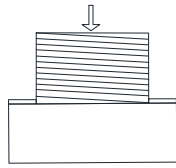
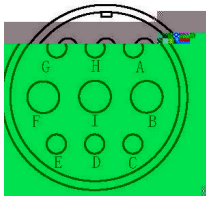

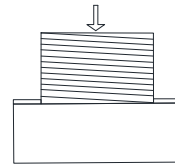
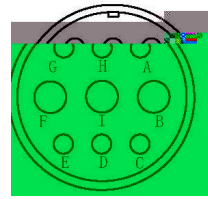

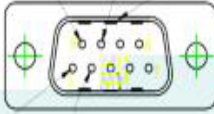

DB9 接口



电机端编码器

95 84

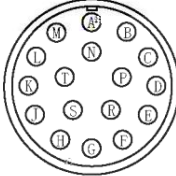

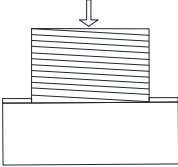

95 84

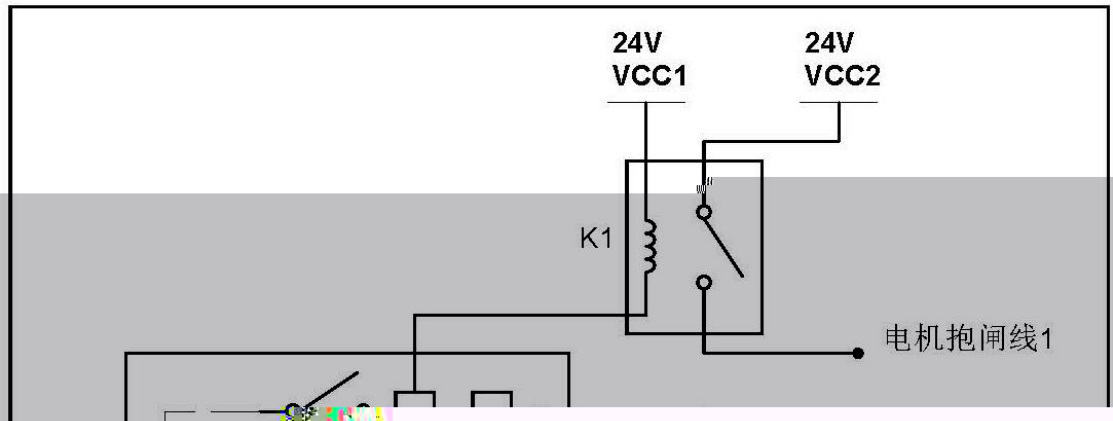

PLC控制变频器

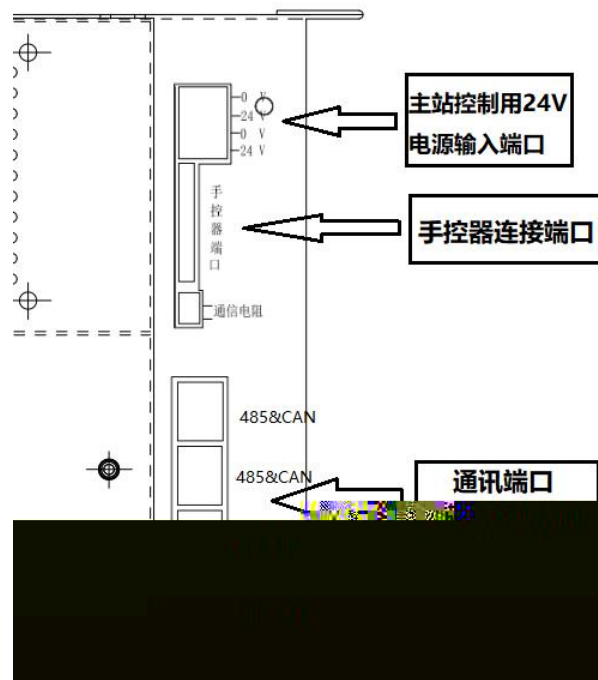
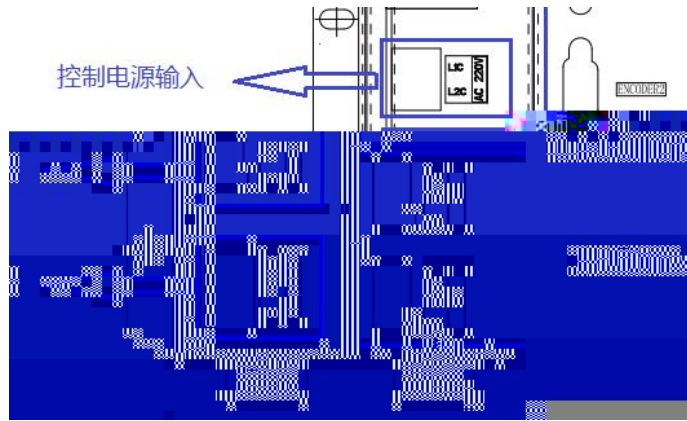

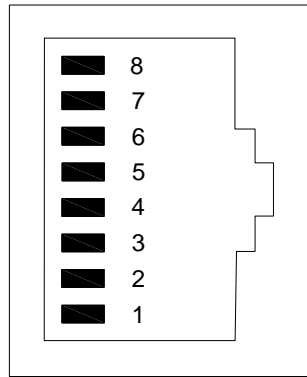

CAN1

	A	B
1		
2		CANL
3	2#	CANH
4	3#	0V-ISO
5	4#	485-1A
6	5#	485-1B
7	6#	GND
8	7#	485-2A
9	8#	485-2B

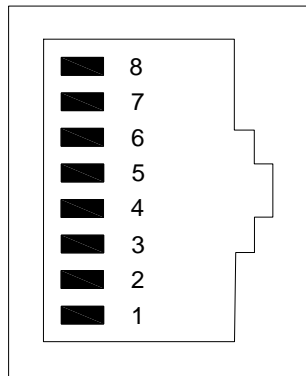

CAN2

	A	B
1		
2		CANL
3	2#	CANH
4	3#	0V-ISO
5	4#	485-1A
6	5#	485-1B
7	6#	GND
8	7#	485-2A
9	8#	485-2B

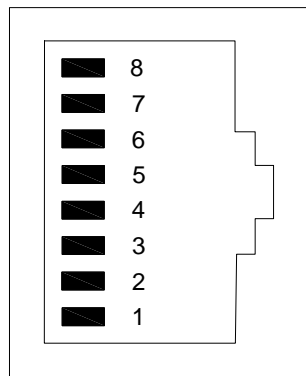

Monitor

	A	B
1		
2		TX+
3	2#	TX-
4	3#	R+
5	4#	NC
6	5#	NC
7	6#	R-
8	7#	NC
9	8#	NC

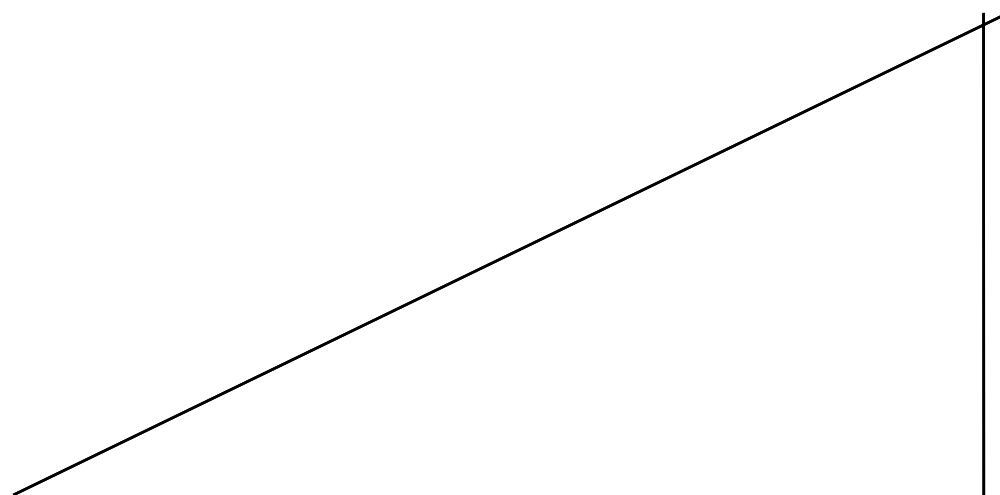
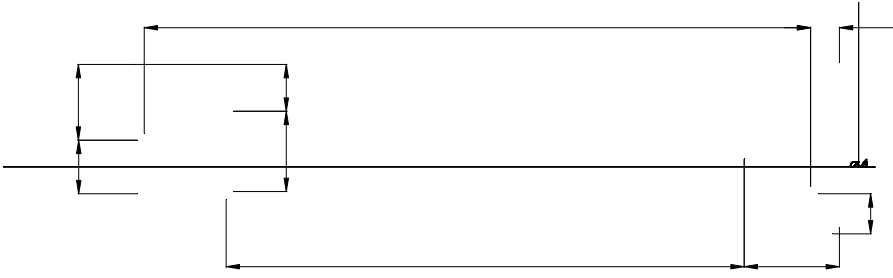

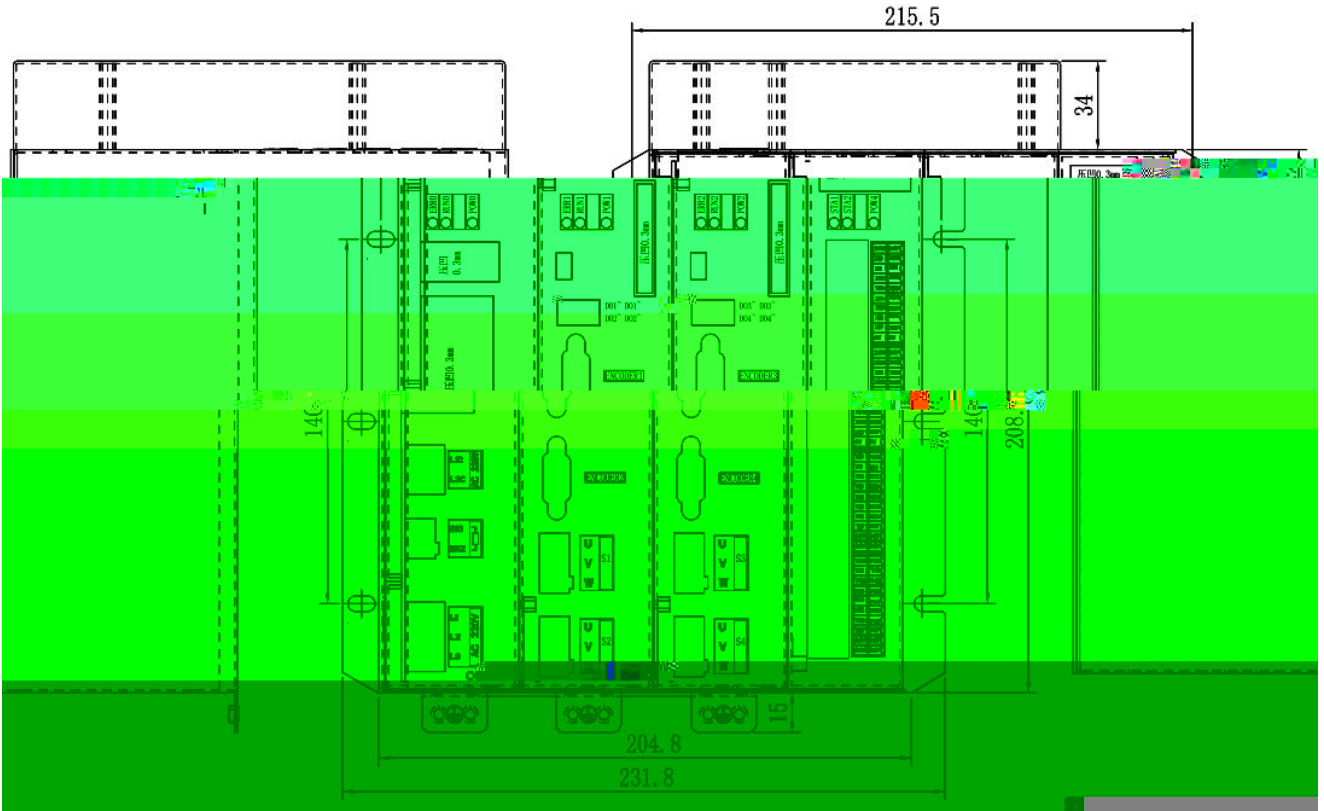

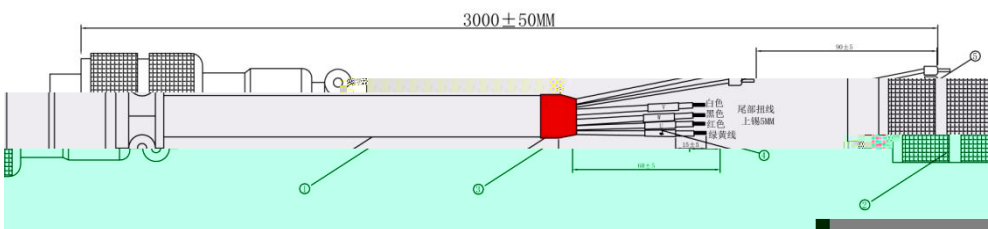
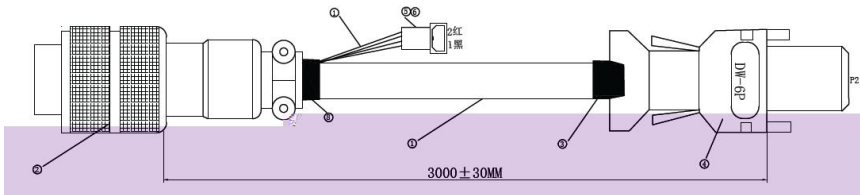
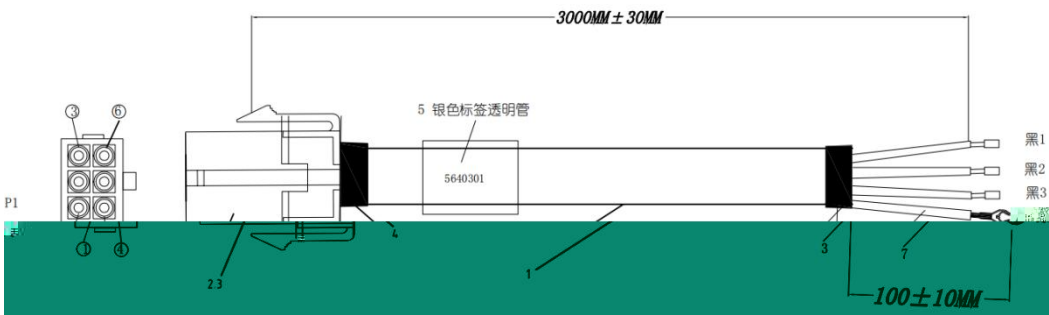
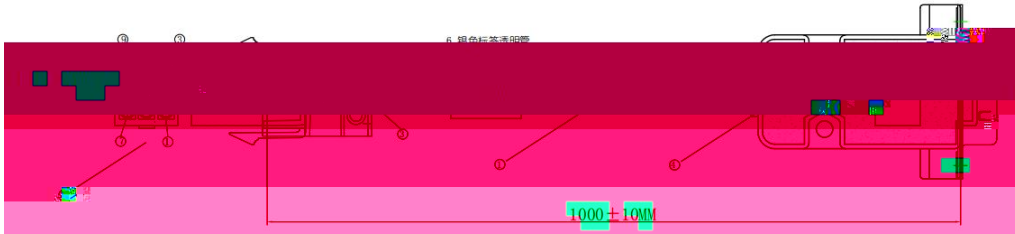

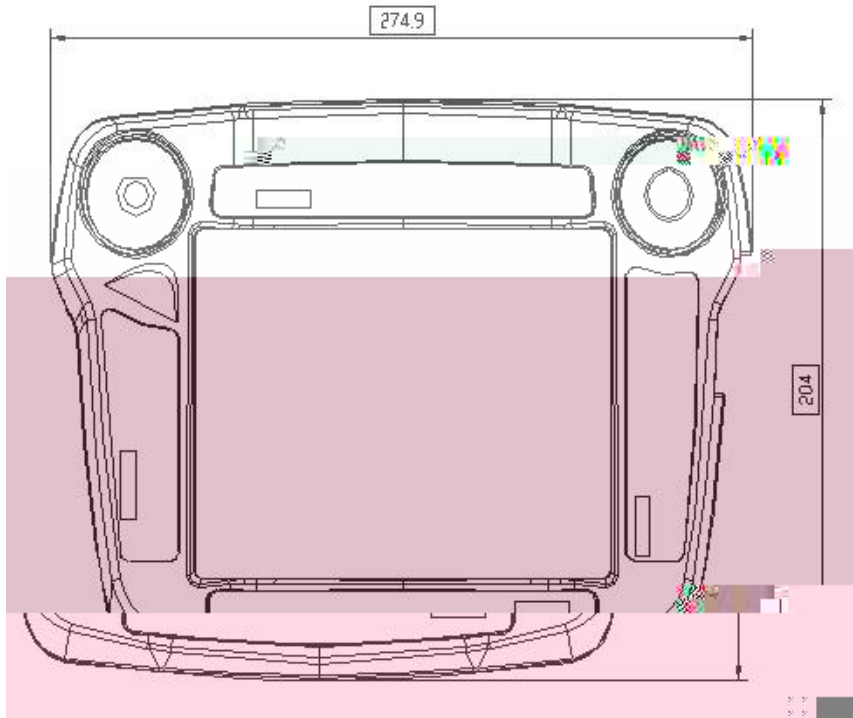

品名：12P航空头转接线 L=0.5M

